

FIG. 15

FIG. 16

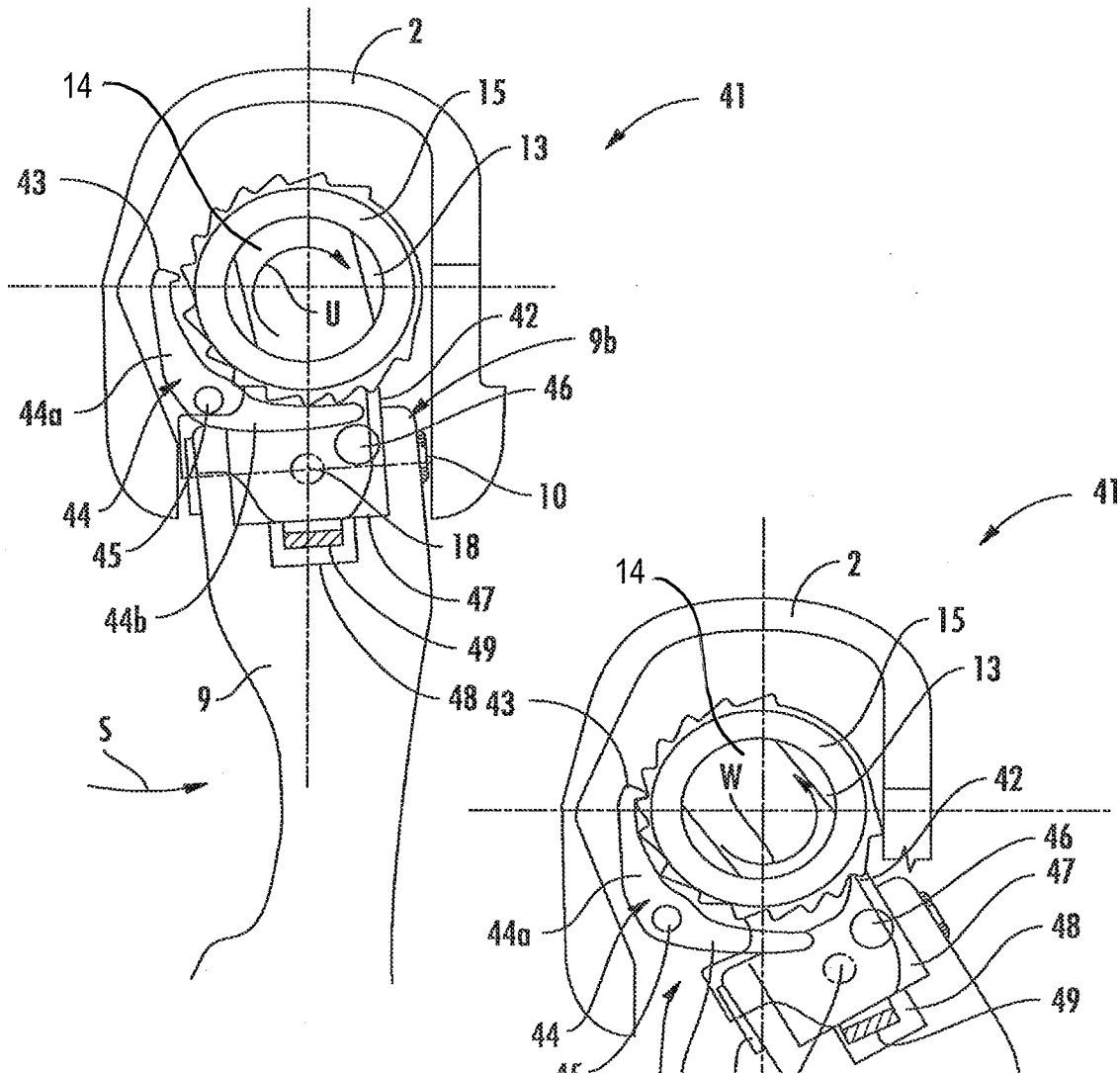

FIG. 17

FIG. 18