

FIG. 4

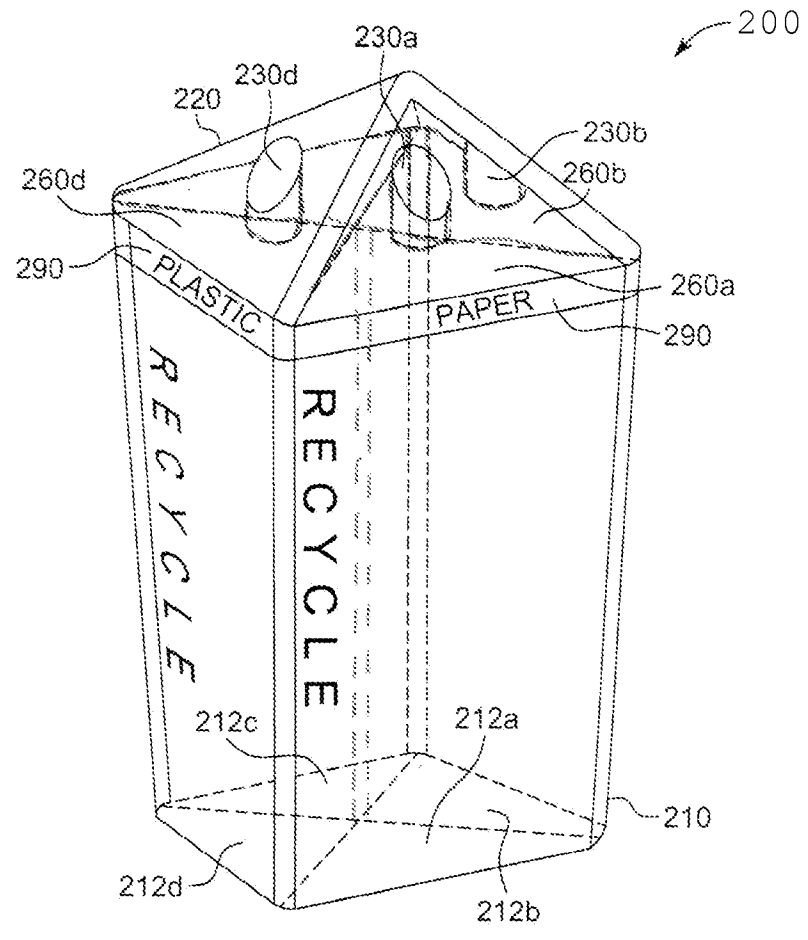

FIG. 5

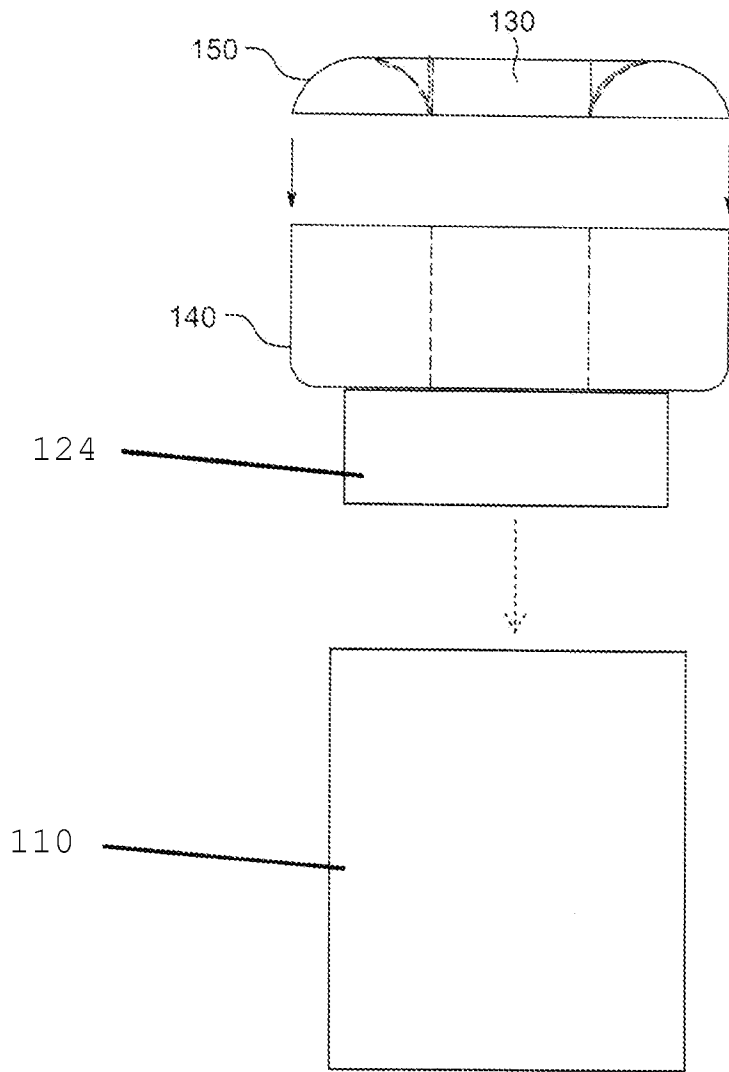

FIG. 4a