

FIG. 1

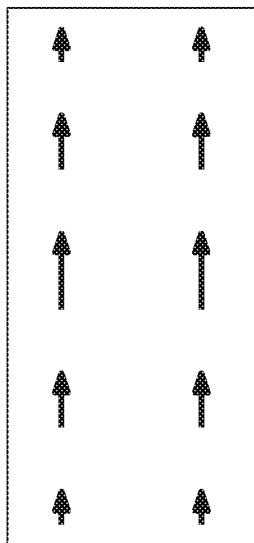

FIG. 2A

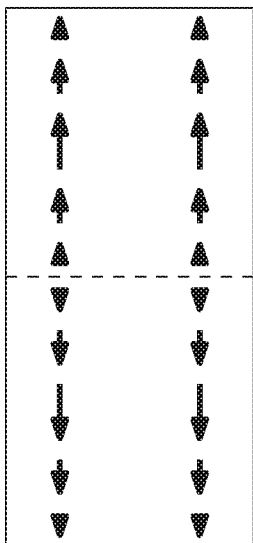

FIG. 2B

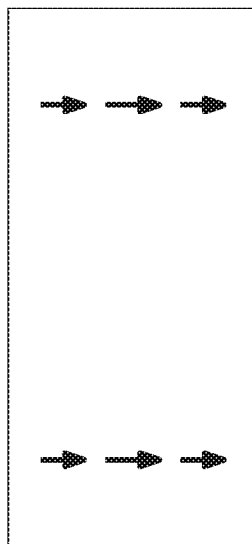

FIG. 2C

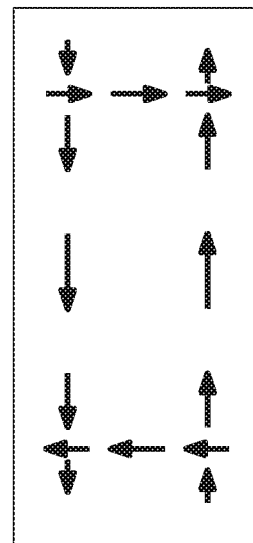

FIG. 2D

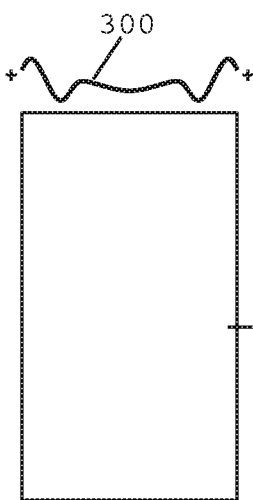

FIG. 3A

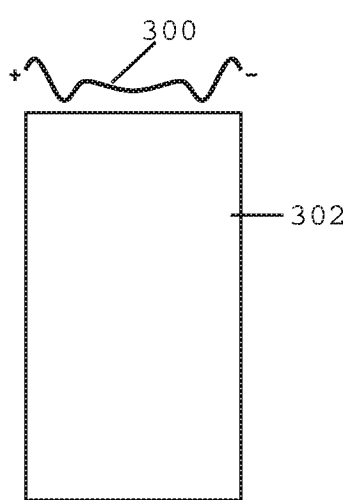

FIG. 3B

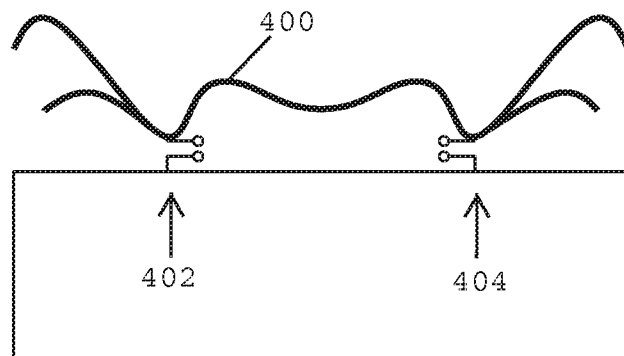

FIG. 4

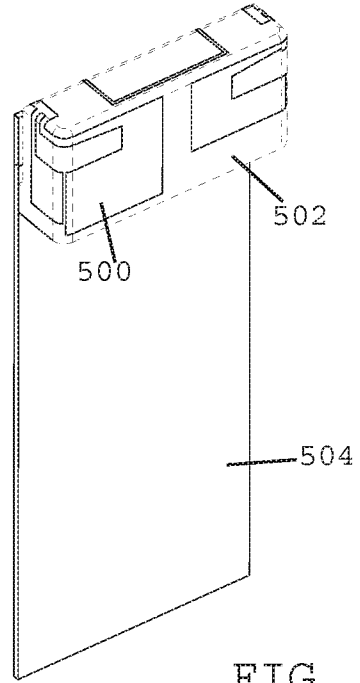

FIG. 5A

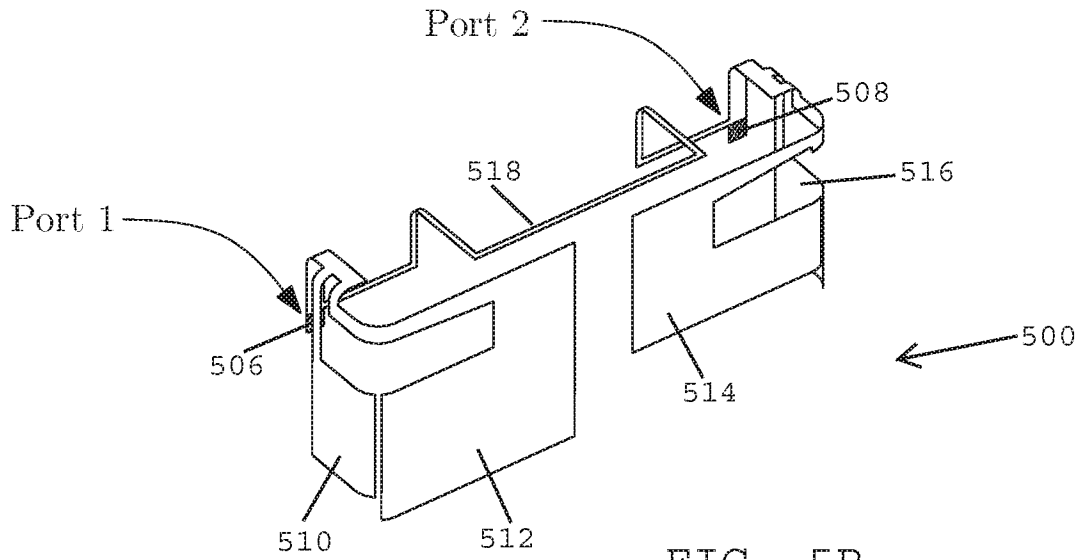

FIG. 5B

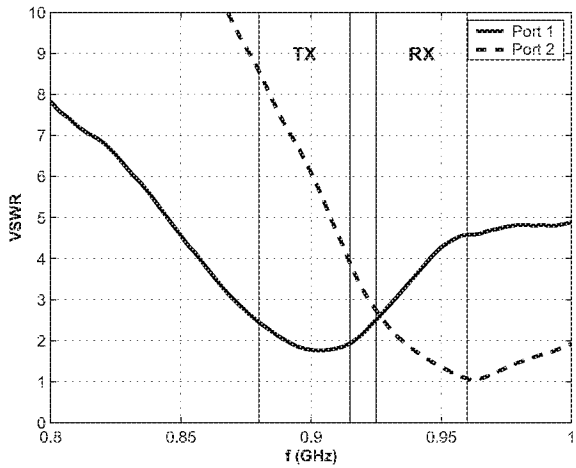

FIG. 6A

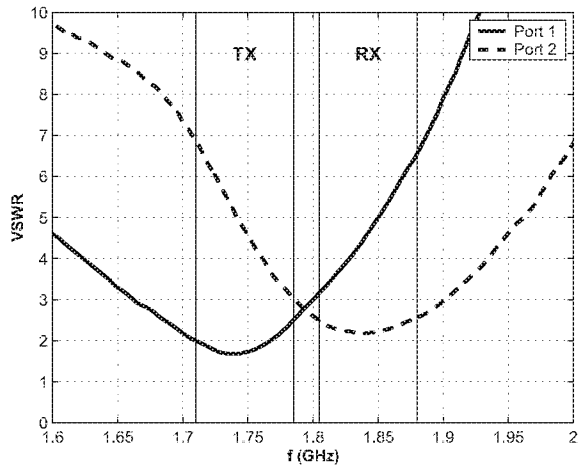

FIG. 6B

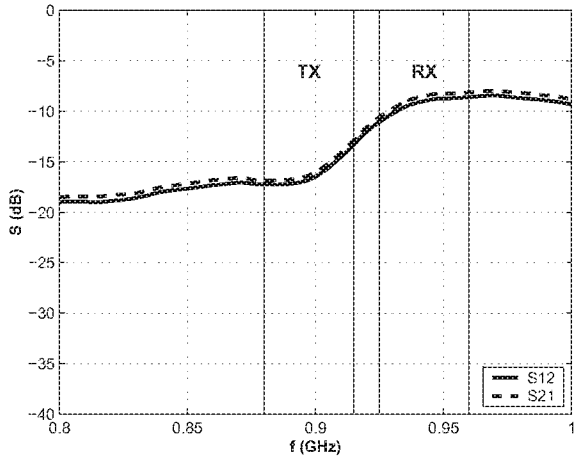

FIG. 6C

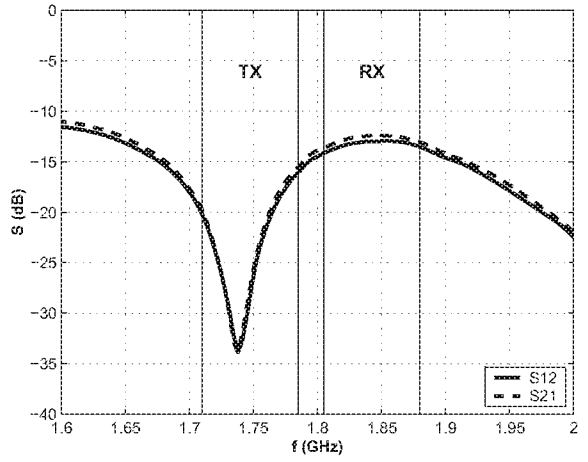

FIG. 6D

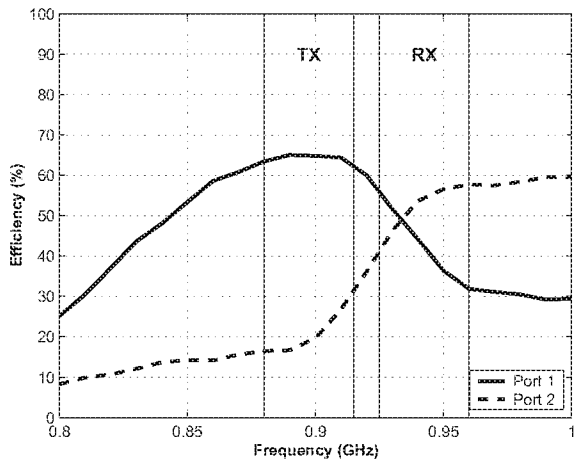

FIG. 6E

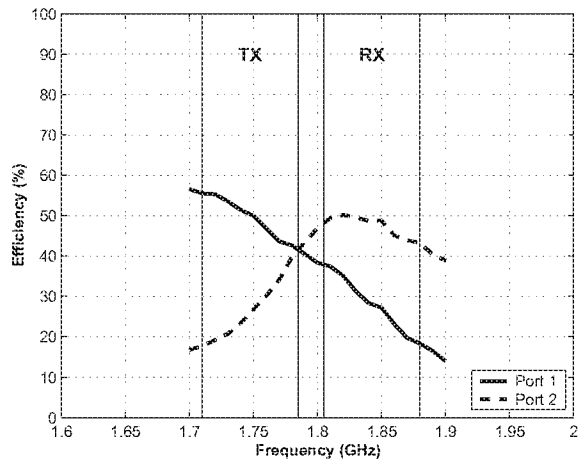

FIG. 6F

Protocol		Frequency		
GSM900	TX	880-915 MHz	10 MHz	GSM Europe
	RX	925-960 MHz		
GSM1800	TX	1710-1785 MHz	20 MHz	
	RX	1805-1880 MHz		
GSM850	TX	824-849 MHz	20 MHz	GSM North America
	RX	869-894 MHz		
GSM1900	TX	1850-1910 MHz	20 MHz	
	RX	1930-1990 MHz		
WCDMA	TX	1920-1980 MHz	130 MHz	WCDMA
	RX	2110-2170 MHz		

FIG. 7

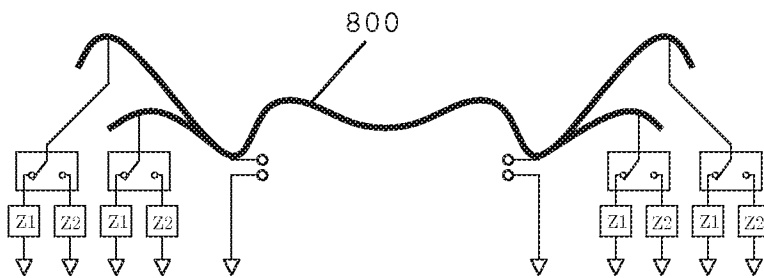

FIG. 8

Two switch states required to cover GSM Quad-band

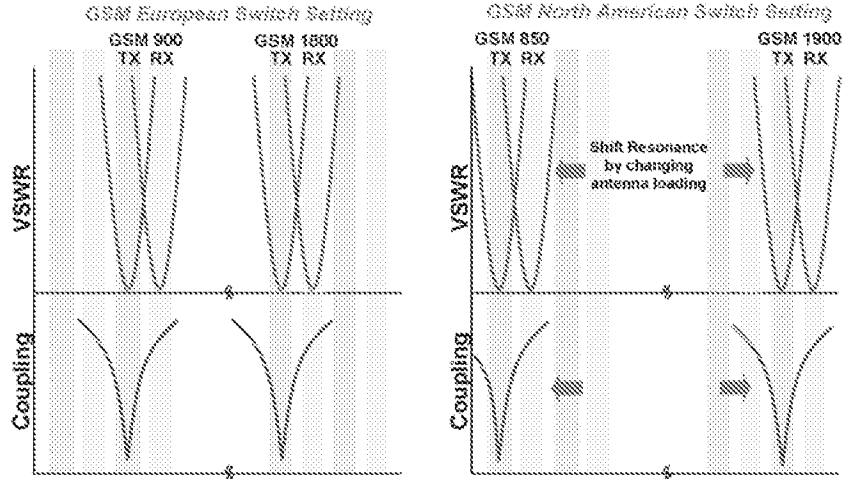

FIG. 9

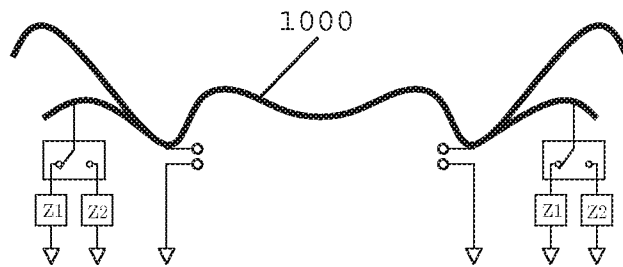

FIG. 10

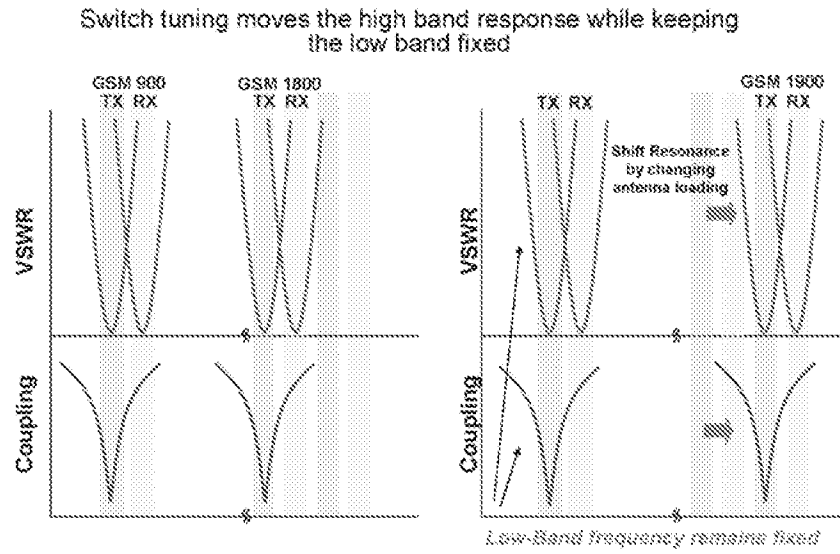

FIG. 11

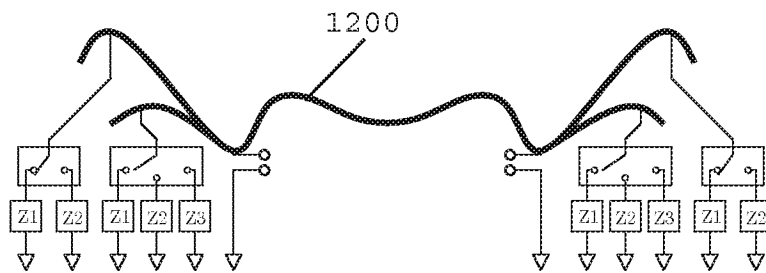

FIG. 12

Add another switch state to cover WCDMA frequencies

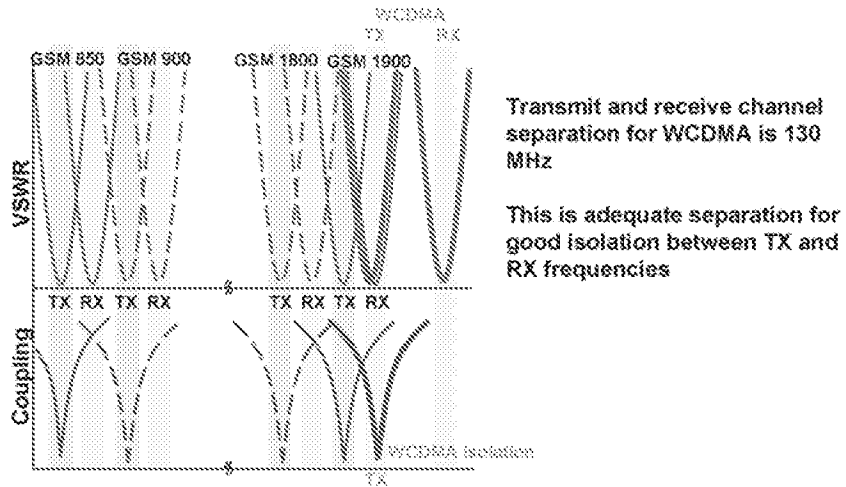

FIG. 13